



■ Vers. 064



■ Vers. 003







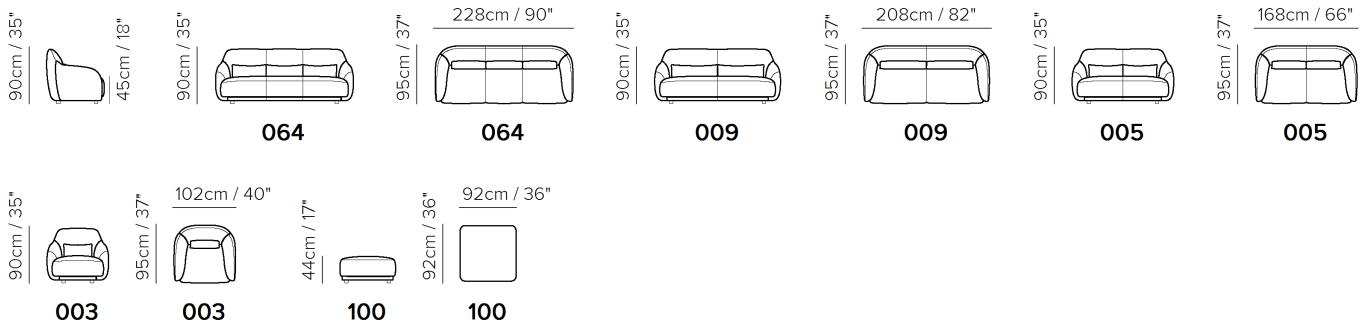

■ Vers. 100

SCHEMATICS



TECHNICAL INFORMATION

	COVERING	Mix <input checked="" type="checkbox"/>	Leather <input checked="" type="checkbox"/>	Soft Cover <input checked="" type="checkbox"/>			
	LEGS	Wood <input type="checkbox"/>	Metal <input type="checkbox"/>	Plastic <input type="checkbox"/>	Castors <input type="checkbox"/>	Upholstered <input type="checkbox"/>	
	FILLING	Arms	<input type="checkbox"/> Fiber <input type="checkbox"/> Foam <input type="checkbox"/> Feather/Fiber Mix <input type="checkbox"/> Feather	Seat cushion	<input type="checkbox"/> Fiber <input type="checkbox"/> Foam <input type="checkbox"/> Feather/Fiber Mix <input type="checkbox"/> Feather	Back cushion	<input type="checkbox"/> Fiber <input type="checkbox"/> Foam <input type="checkbox"/> Feather/Fiber Mix <input type="checkbox"/> Feather
	COMFORT	Standard Comfort <input checked="" type="checkbox"/>	Firm Comfort <input checked="" type="checkbox"/>				
	FUNCTION	Bed <input type="checkbox"/>	Electric motion <input type="checkbox"/>	Motion <input type="checkbox"/>	Recliner <input type="checkbox"/>	Sliding <input type="checkbox"/>	
	OPTIONS	Nails <input type="checkbox"/>	Removable <input type="checkbox"/>	Contrast Stitching <input type="checkbox"/>			

NOTES

- Available in leather (TG only) or fabric.
- Leather/Fabric MIX CATEGORIES are based on the STARTING PRICE CATEGORY OF LEATHER combined with fabric = cat. 1A (cat.10 + fabric) - 1B (cat.15 + fabric) - 2A (cat. 20 ...) - 2B (cat. 25 ...) - 3A (cat. 30 ...)
- LEATHER-FABRIC MIX:
- 1° Cov. (Leather): outside body
- 2° Cov. (Fabric): seat, lumbar and back cushion in fabric

NOTES
